

# US 60 K 2500 AI-TSSL

## Ultrasonic Sensor

- Robust casing
- Compact design
- Zero and full scale adjustable
- Scanning range adjustable
- Insensitive to dirt
- Insensitive to ambient noise
- Scanning does not depend on surface
- Analog output
- High follow-up speed
- High resolution
- Piezo-ceramic composite transducer

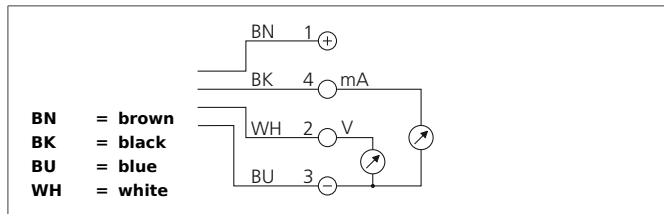

### Safety instructions

The Instruments are not to be used for safety applications, in particular applications in which safety of persons depends on proper operation of the instruments.  
 These instruments shall exclusively be used by qualified personnel.

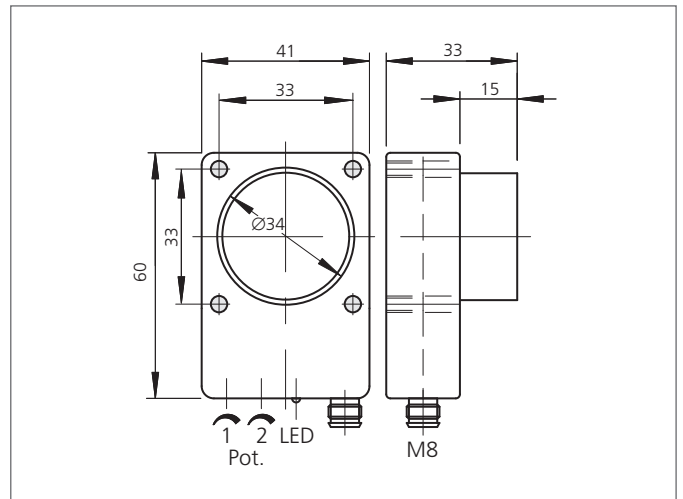

TECHNICAL INFORMATION (typ.)		+20°C, 24V DC
Operating principle		Ultrasonic sensor
Evaluation		analog
Size		60 x 41 x 33 mm (Dimensions)
Design		cuboid design
Service voltage		15 ... 30 V DC
Internal power consumption		80 mA
Operating distance		250 ... 3.000 mm
Resolution		0,1 % / Sn max.
Switching output		Analog output (2x)
Analog output		0 ... 10 V, 4 ... 20 mA
Tracking speed		400 ms (95% Sn max.)
Operating frequency		120.000 Hz
Ripple		15 mV
Linearity analog output		< 0,5 % / Sn max.
Accuracy		< 1 % / Sn max.
Ambient temperature		-20 ... +50 °C
Temperature error		1 % (-20 ... +50°C)
Load resistance		> 10.000 Ω / < 400 Ω
Insulation voltage endurance		500 V
Protection class		IP 67
Casing material		polyamide
Connection		Connector, M8, 4-poled